

STEEL TRUCK DOCKBOARD - TS-15-6072

APPROX WEIGHT: 546.80 lbs.
DOES NOT INCLUDE WEIGHT OF POWER OR PACKAGING!!!

*** ANY ADDITIONS, DELETIONS, OR OMISSIONS MUST BE CORRECTED ON THIS DRAWING AS THIS DRAWING WILL BE CONSIDERED ALL INCLUSIVE ***

ALL GRAPHICS PROVIDED ARE FOR REFERENCE ONLY. IF CERTAIN DIMENSIONS ARE CRITICAL PLEASE VERIFY THOSE DIMENSIONS WITH YOUR SALESPERSON

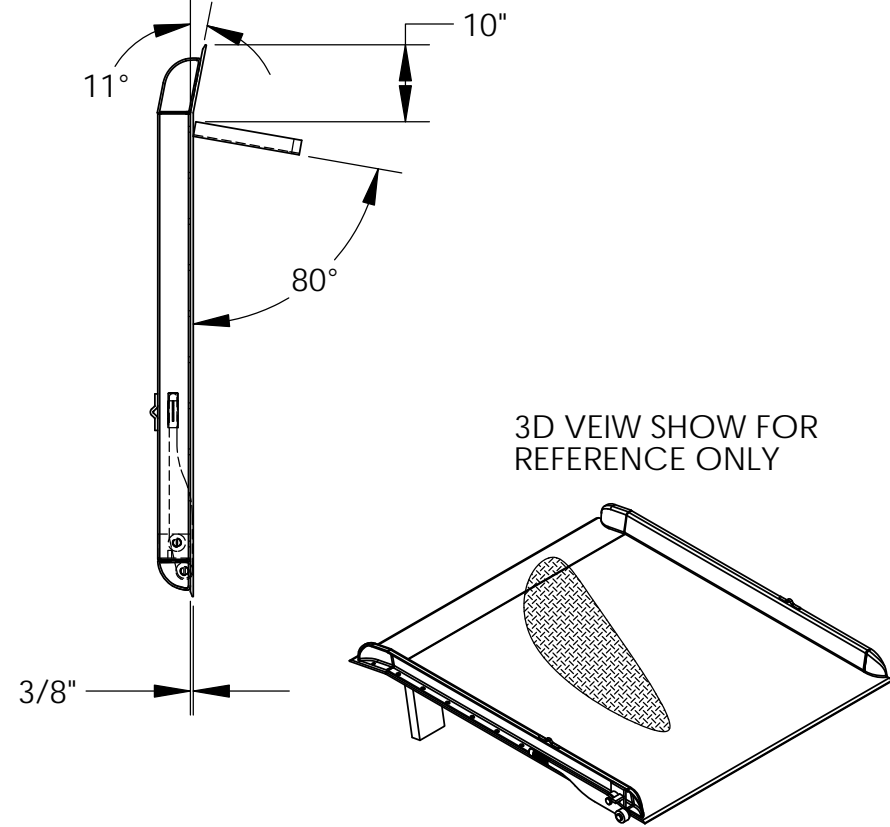
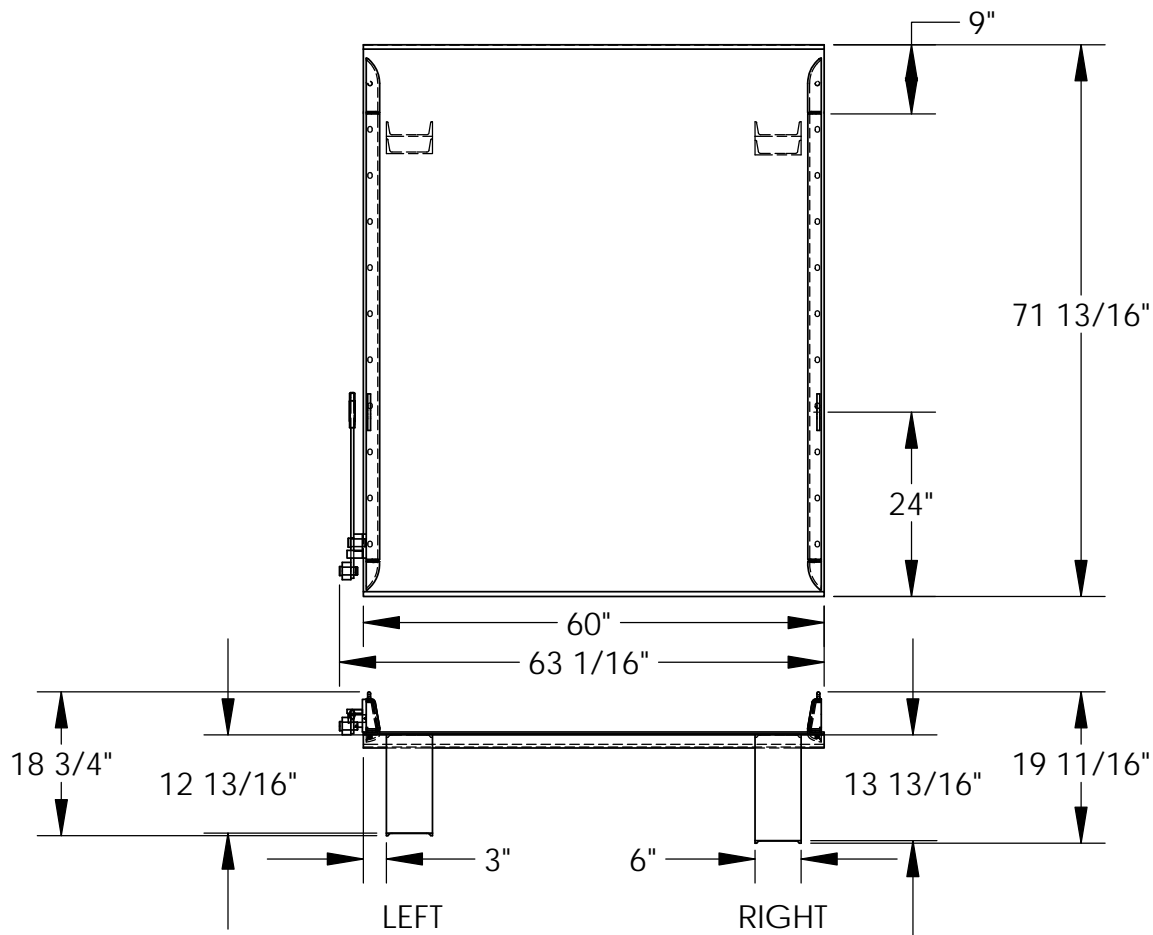

DIMENSION TOLERANCE $\pm 1/4"$

STANDARD FEATURES

- MODEL NUMBER: TS-15-6072
- CAPACITY: 15,000 LBS
- OVERALL WIDTH: 63 1/16"
- OVERALL LENGTH: 71 13/16"
- DOCKPLATE THICKNESS: 3/8"
- LEVER LIFT IS STANDARD
- LOCKING LEGS ARE 6" WIDE
- RIGHT LEG LENGTH IS 13 13/16"
- LEFT LEG LENGTH IS 12 13/16"
- CROWN IS 11° & 9" FROM EDGE
- HEIGHT DIFFERENCE: 12"

SPECIAL FEATURES

NONE

APPROVAL	I, THE UNDERSIGNED, AGREE THAT THE PRODUCT AS REPRESENTED SATISFIES DESIGN AND DIMENSION REQUIREMENTS. I ALSO ACKNOWLEDGE MY DUTY TO CONFIRM PRODUCT AND INSTALLATION COMPLIANCE WITH ALL APPLICABLE FEDERAL, STATE AND LOCAL REGULATIONS AND STANDARDS.	
	ANY MODIFIED UNITS ARE NON-RETURNABLE	
	[] As drawn [] As marked	
	Signed: _____	Date: _____
Printed Name: _____		
LEAD TIME WILL START UPON RECEIPT OF SIGNED APPROVAL DRAWING		

FOR INTERNAL USE ONLY PROJECT SIGN OFF	
SALES	
ENG.	
FAB.	
POWER	

DISTRIBUTOR'S NAME:		P.O.#
VESTIL MANUFACTURING		X
DRAWN BY: ADL	DATE: 12/21/2005	W.O.#
REFERENCE: X	SCALE: 1:25	X
QUOTED LEAD TIME: X	QUOTE #	FILE NAME:
	X	10-007-041