



**APPENDIX A: MANUFACTURER'S CLOSURE INSTRUCTIONS**

 <b>DANGEROUS</b> <b>GOODS</b> A DIVISION OF BERLIN PACKAGING				<b>Catalog #</b> <b>HMS-66500</b>		
Variable #1: 1 x 8 oz. Flint Glass Bottle with 58 mm Urea Closure and Vermiculite (4GV – Complete Package)						
Variable #2: 1 x 8 oz. Flint Glass Bottle with 58 mm Urea Closure and Polypropylene Pad (4GV – Complete Package)						
Variable #3: 1 x 8 oz. Amber Glass Bottle with 45 mm Urea Closure and Vermiculite(Special Permit DOT-SP 9168 – Inner Packaging System)						
Variable #4: 1 x 8 oz. Plastic Bottle with 43 mm Polypropylene Closure and Vermiculite(Special Permit DOT-SP 9168 – Inner Packaging System)						
Variable #5: 1 x 8 oz. Amber Glass Bottle with 45 mm Urea Closure and Polypropylene Pad (Special Permit DOT-SP 9168 – Inner Packaging System)						
Variable #6: 1 x 8 oz. Plastic Bottle with 43 mm Polypropylene Closure and Polypropylene Pad (Special Permit DOT-SP 9168 – Inner Packaging System)						
<b>Regulatory Information</b>						
UN Mark:		4GV/X1.2/S/**/USA/+AA4035				
This package was tested to:						
Variable:	Packing Group:	Gross Mass:	Specific Gravity:	Bottle Tested:	Closure Tested:	Closure Torque:
1	I (X)	1.2 Kg	2.0	8 oz. Flint Glass	58 mm	30 In-Lbs.
2			2.03	8 oz. Flint Glass	58 mm	30 In-Lbs.
3		N/A	1.6	8 oz. Amber Glass	45 mm	30 In-Lbs.
4			2.0	8 oz. Plastic	43 mm	22 In-Lbs.
5			1.6	8 oz. Amber Glass	45 mm	30 In-Lbs.
6			2.0	8 oz. Plastic	43 mm	22 In-Lbs.
Closing Methods:		Top Flaps:	2" 3M #375 Tape			
		Bottom Flaps:	2" 3M #375 Tape			
Kits also covered under this test:						
HMS-66460, HMS-66500, HMS-66502, HMS-6650M, HMS-66510 6, HMS-6651M, HMS-66520, HMS-66521, HMS-6652M, HMS-66530, HMS-6653M, HMS-66540, HMS-6654M, HMS-66560, HMS-6656M, HMS-66570, HMS-68440 & HMS-68450						
<b>Disclaimer:</b>						
It is the responsibility of each person offering a hazardous material for transportation to ensure that such packaging is compatible with their lading. Failure to heed this warning could result in a serious incident.						
PA Warehouse: 1195 Washington Pike, Bridgeville, PA 15017					800.413.8867	
BerlinDangerousGoods.com						

 <b>DANGEROUS</b> <b>GOODS</b> A DIVISION OF BERLIN PACKAGING		<b>Catalog #</b> <b>HMS-66500</b>
<b>Package Details</b>		
<u>Package Contents:</u>		
<u>Item</u>	<u>Description</u>	<u>Quantity</u>
COR-H81960502	Carton	1
COR-H71960602	Die-Cut Corrugated Insert	1
HMS-8112R	Plastic Bag	1
HMS-81968	Plastic Bag	1
HMS-81330	8" Nylon Cable Tie	2
HMS-10810	Slip Fit Metal Can with Cover	1
HMS-96040	1" x 10" Tape Strips	3
HMS-81171	Polypropylene Absorbent Sheet	1
HMS-89000	Vermiculite	n/a
HMS-96905	Fiber Core	1
CAP-00074	58 mm Urea Closure	1
GLA-00846	8 oz. Flint Glass Bottle	1
CAP-00067	45 mm Urea Closure	1
GLA-00919	8 oz. Amber Glass Bottle	1
PLA-03173	8 oz. Plastic Bottle with Closure	1
<u>Transportation:</u>		
Transportation Mode:	Contact Berlin Packaging when Shipment is other than Ground Transportation.	
<b>Disclaimer:</b>		
It is the responsibility of each person offering a hazardous material for transportation to ensure that such packaging is compatible with their lading. Failure to heed this warning could result in a serious incident.		
PA Warehouse:	1195 Washington Pike, Bridgeville, PA 15017	800.413.8867
		BerlinDangerousGoods.com

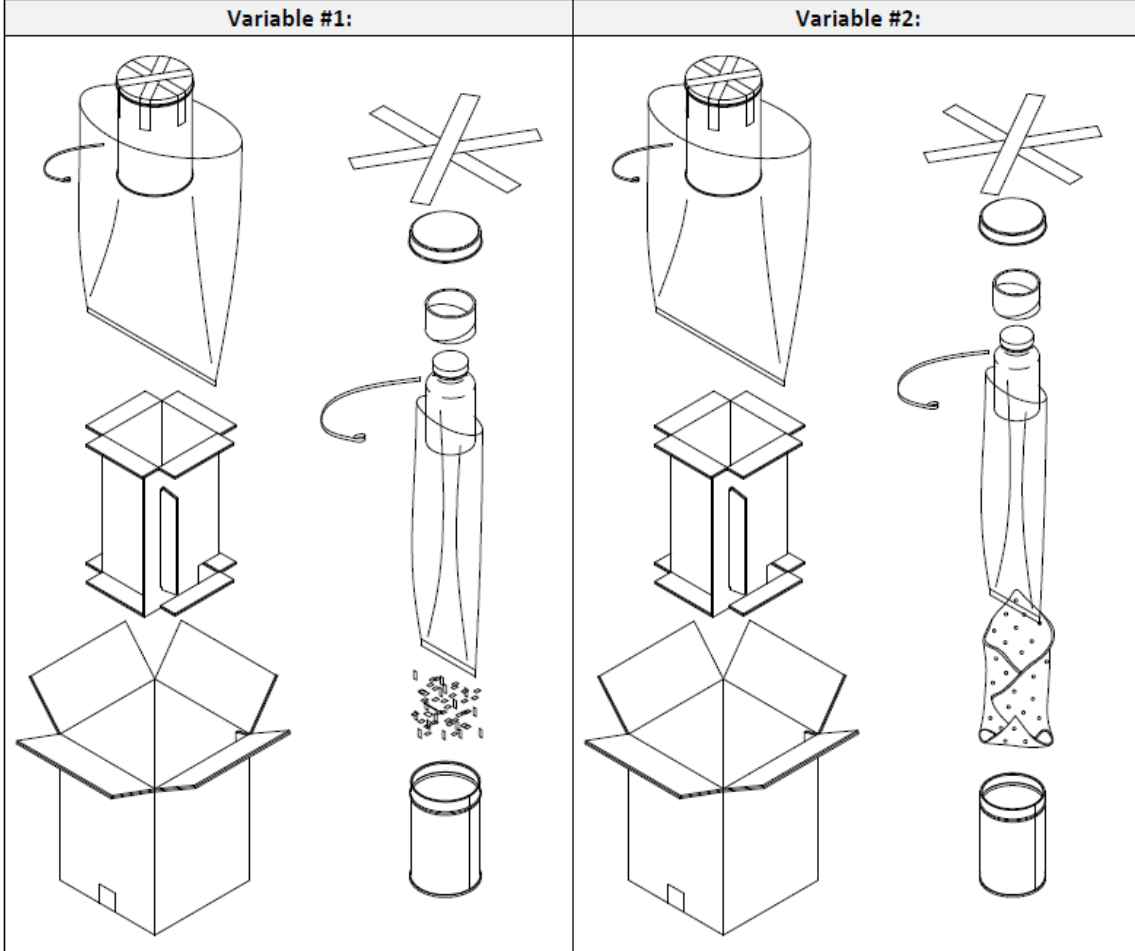

 <b>DANGEROUS</b> GOODS A DIVISION OF BERLIN PACKAGING	Catalog #
	HMS-66500

Variable #1: 1 x 8 oz. Flint Glass Bottle with 58 mm Urea Closure and Vermiculite (4GV – Complete Package)  
 Variable #2: 1 x 8 oz. Flint Glass Bottle with 58 mm Urea Closure and Polypropylene Pad (4GV – Complete Package)

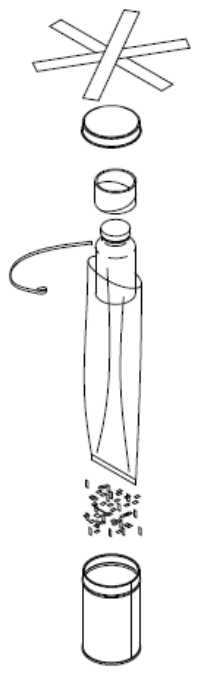
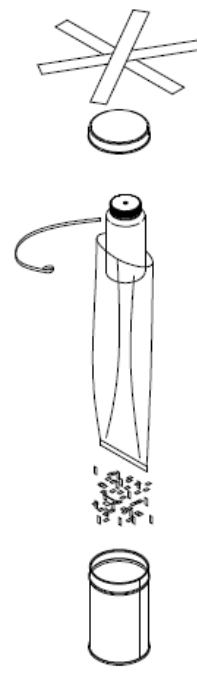

**Disclaimer:**  
 It is the responsibility of each person offering a hazardous material for transportation to ensure that such packaging is compatible with their lading. Failure to heed this warning could result in a serious incident.

PA Warehouse: 1195 Washington Pike, Bridgeville, PA 15017 800.413.8867  
 BerlinDangerousGoods.com

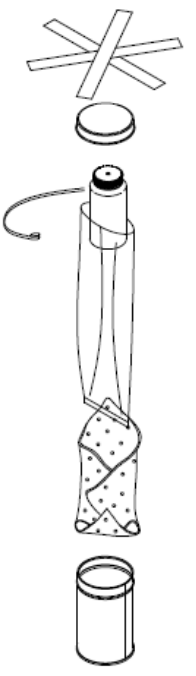
			<b>Catalog #</b>  <b>HMS-66500</b>
<b>Variable #3: 1 x 8 oz. Amber Glass Bottle with 45 mm Urea Closure and Vermiculite(Special Permit DOT-SP 9168 – Inner Packaging System)</b>			
<b>Variable #4: 1 x 8 oz. Plastic Bottle with 43 mm Polypropylene Closure and Vermiculite(Special Permit DOT-SP 9168 – Inner Packaging System)</b>			
<b>Variable #5: 1 x 8 oz. Amber Glass Bottle with 45 mm Urea Closure and Polypropylene Pad (Special Permit DOT-SP 9168 – Inner Packaging System)</b>			
<b>Variable #6: 1 x 8 oz. Plastic Bottle with 43 mm Polypropylene Closure and Polypropylene Pad (Special Permit DOT-SP 9168 – Inner Packaging System)</b>			
<b>Variable #3:</b>	<b>Variable #4:</b>	<b>Variable #5:</b>	<b>Variable #6:</b>
			
<b>Disclaimer:</b> It is the responsibility of each person offering a hazardous material for transportation to ensure that such packaging is compatible with their lading. Failure to heed this warning could result in a serious incident.			
PA Warehouse: 1195 Washington Pike, Bridgeville, PA 15017		800.413.8867	
<a href="http://BerlinDangerousGoods.com">BerlinDangerousGoods.com</a>			