

REV. B	DWG #: 23-024-137	REV.	ECR #	DATE	REVISIONS	INITIAL
		A		3/12/03	WAS PRT GR-6	PE
		B		8/07/06	UPDATED POWDER COAT NOTE	QW

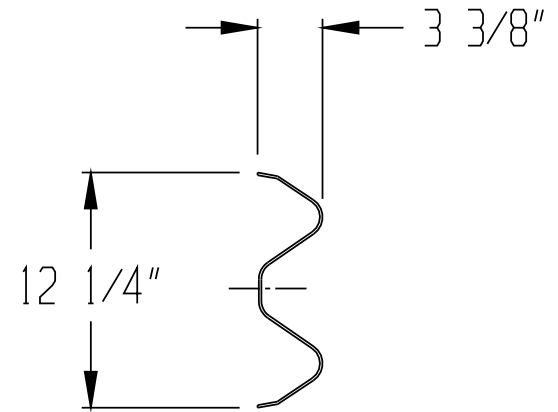
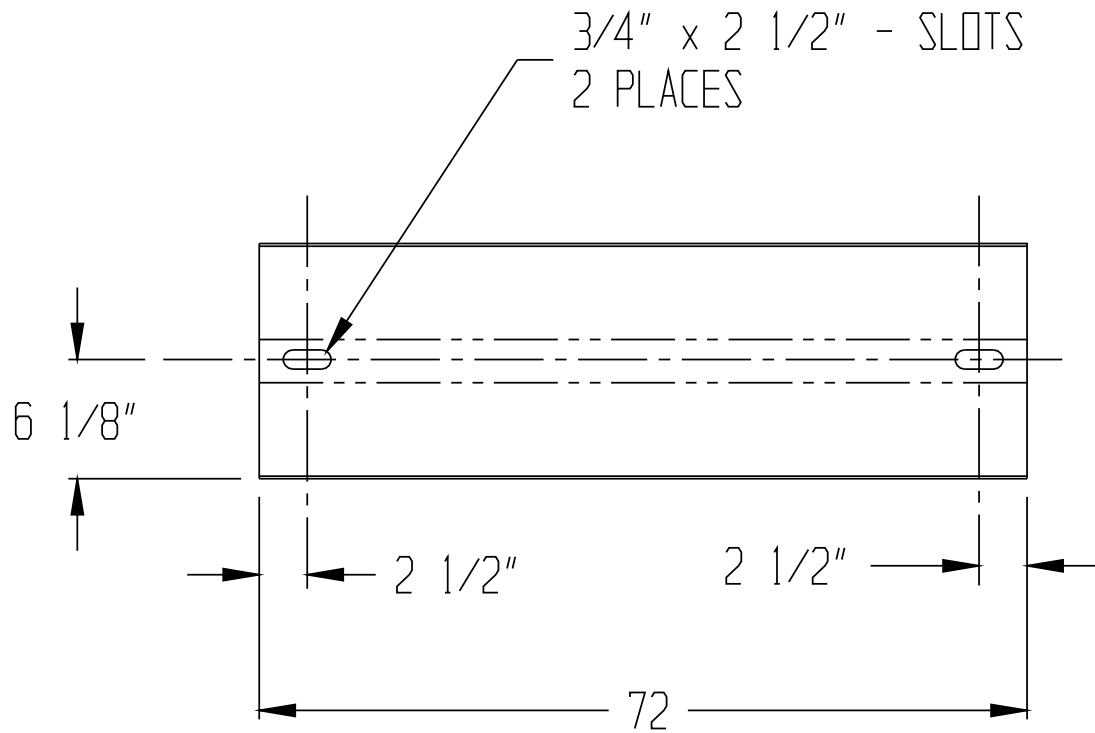

STANDARD
GUARDRAIL
SECTION

UNIT POWDER COATED YELLOW

*PREVIOUS PART NUMBER GR-6-Y

THIS PRINT IS CONFIDENTIAL AND IS THE PROPERTY OF
T & S EQUIPMENT CO.
THIS PRINT SHALL NOT BE USED, COPIED OR REPRODUCED IN WHOLE OR IN PART NOR SHALL THE CONTENTS BE REVEALED IN ANY MANNER TO ANYONE UNLESS WRITTEN PERMISSION IS OBTAINED FROM T & S EQUIPMENT CO.

REMOVE ALL BURRS AND SHARP EDGES		
CONCENTRIC	.006 TIR	.060 TIR
ANGLES	+/- 0° 30'	+/- 1° 0'
DECIMALS	x.xxx +/- .005 x.xx +/- .010 x.x +/- .025	+/- .015
FRACTIONS	+/- 1/32	+/- 1/16
TOLERANCE	MACHINE	WELDMENT

T & S EQUIPMENT COMPANY			
GUARD, GUARDRAIL W/SLOT LAYOUT, GR-6-PC-YEL			
ROUGH PRT NUMBER:	SCALE: NTS	DRAWN BY: GT / PE	
MATERIAL:	DATE: 3/12/03	DRAWING NO:	REV:
10 GA PLAIN	APP'D:	23-024-138	B